

VEHICLE FIRE SUPPRESSION SYSTEM

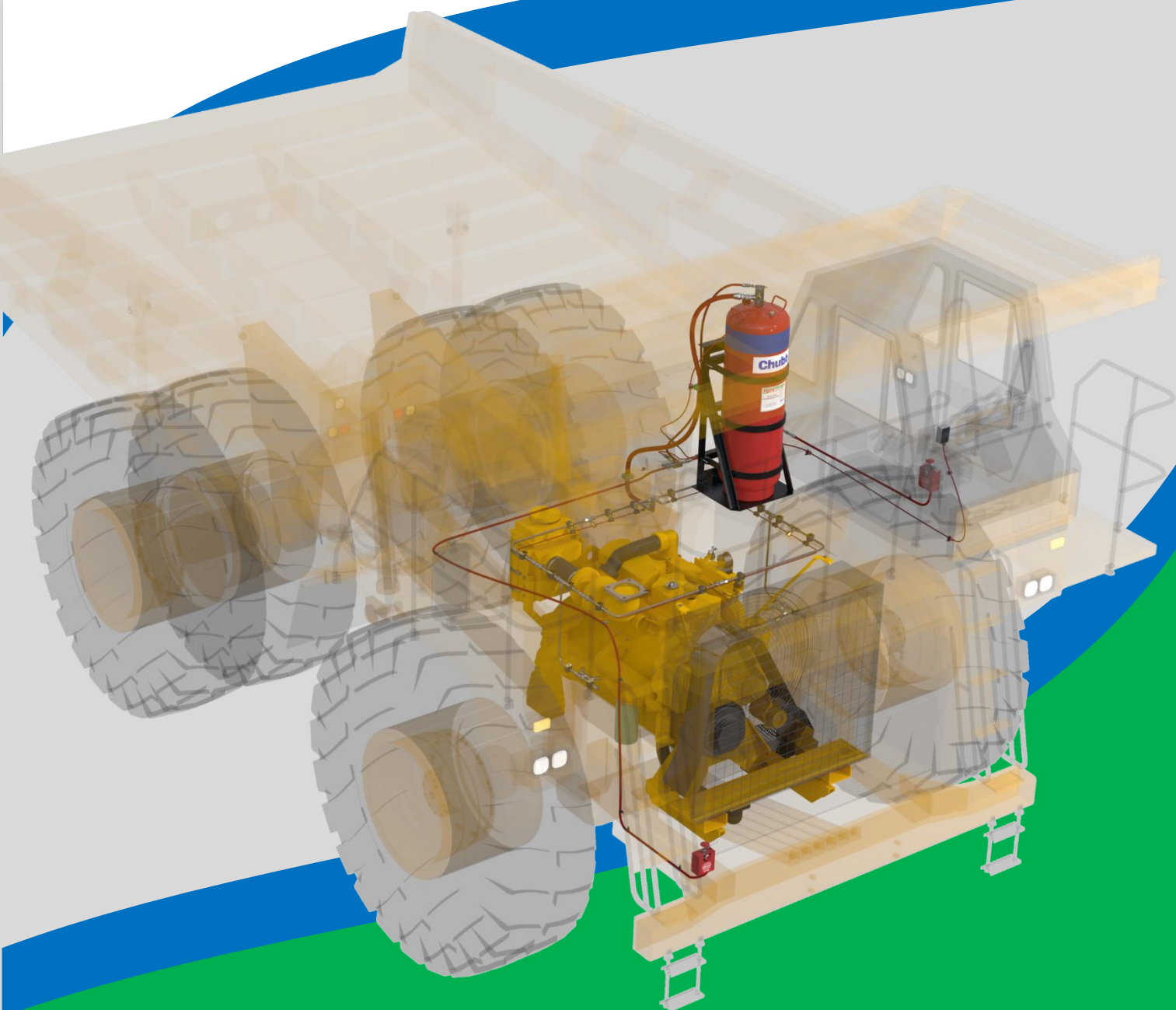

Maintenance Manual

PREFACE

Document History

Version	Summary of Change
1.0	Original

This manual is an uncontrolled document. Chubb Fire & Security Pty Ltd (“Chubb”) reserves the right to alter this manual at any time in accordance with our policy of continuous development. Chubb welcomes feedback regarding this manual and associated equipment.

For further information or feedback, **contact Chubb on 13 15 98.**

Contents

PREFACE	2
Document History.....	2
Contents.....	3
About this manual.....	5
Warranty.....	5
<i>Consumer Guarantees</i>	5
<i>Intended use</i>	6
Introduction.....	7
MAINTENANCE	8
General.....	8
<i>Precautions</i>	8
<i>Pre-Maintenance Review (Design Survey)</i>	8
<i>Water Quality</i>	8
<i>System Defects</i>	9
<i>Service Records</i>	9
<i>Recommended Tool List</i>	10
Service Schedule.....	11
<i>Daily Routine Service Schedule</i>	11
<i>Six-monthly and Yearly Routine Service Schedule</i>	11
Six Monthly Service Instructions.....	14
<i>System pressure check (Item 1)</i>	14
<i>System control and indicating equipment [where fitted] (Item 2)</i>	14
<i>Distribution system (Item 3)</i>	14
<i>Actuation system (Item 4)</i>	16
<i>Manual Actuators (Item 5)</i>	16
<i>Detection System (Item 6)</i>	17
<i>Storage containers (Item 7)</i>	17
<i>System Labels (Item 8)</i>	17
<i>After Maintenance Activities</i>	17
Yearly Service Instructions.....	18
<i>Discharge Test [Optional] (Item 9)</i>	18
<i>Storage containers (Item 10)</i>	18
<i>Cylinder Valve – Service (Item 11)</i>	19
<i>Cylinder Refilling (Item 12)</i>	21
<i>Distribution System – Clear Passage Test (Item 13)</i>	21
<i>Manual Actuators – Service (Item 14)</i>	22
<i>Detection system – Pneumatic (Item 15)</i>	23
<i>Actuation system – Pneumatic (Item 16)</i>	23
<i>Actuation system – Electrical [where fitted] (Item 17)</i>	23
<i>Detection system - Electrical [where fitted] (Item 18)</i>	24
<i>System interface and shutdown [where fitted] (Item 19)</i>	24
<i>System Pressurising</i>	24
<i>After Maintenance Activities</i>	25
MAINTENANCE REPORT	26
SPARE PARTS	27
Cylinder Assemblies & Brackets.....	27
<i>Cylinders Assembles</i>	27
<i>Cylinder Assembly Details:</i>	27
<i>LOP Cylinder Valve</i>	28
<i>Siphon Tubes</i>	28
<i>Fill Kits</i>	28
<i>Over-fill Tubes</i>	28
<i>Cylinder Brackets</i>	29
<i>LOP Valve Actuation Bypass Kit (Optional)</i>	30
Discharge Components.....	30
<i>Stainless Steel Tube</i>	30
<i>Discharge Hose</i>	30
<i>Nozzles</i>	30
<i>Nozzle Kits</i>	31
<i>Discharge Hose and Tube fittings</i>	32
Actuation Components.....	34
<i>Loss of Pressure Detection Tubing</i>	34
<i>Electric Solenoid Valve Assembly</i>	34
<i>Actuation System Fittings</i>	35
Monitoring Components.....	36
<i>Pressure Switches</i>	36
Identification & Instruction Labels.....	37
APPENDIX	38

SDS – Chubb PEFS F3N Foam Concentrate.....	38
AS2337 Cylinder Visual Inspection Damage Limits	45

About this manual

This manual is written for those who maintain PEFS F3N Vehicle Fire Suppression Systems (“PEFS F3N”). It contains maintenance information for the system. While reasonable care has been taken in the preparation of this manual, Chubb Fire & Security Pty Limited (“Chubb”) does not represent or warrant that the information and data contained in this manual is complete, accurate or up to date. Chubb reserves the right to make changes to the manual at any time without notice.

PEFS F3N Systems are to be designed, installed, commissioned, inspected, maintained, and tested only by qualified, trained personnel.

IMPORTANT

No part of this publication may be distributed, reproduced, modified, stored in a retrieval system, or transmitted in any form or by any means, electronic, mechanical, photocopying, or otherwise without the prior written approval of Chubb.

Warranty

Chubb warrants to the original system purchaser (“Customer”) that each new PEFS F3N system is free from defects in material and workmanship under normal use for a period of twelve (12) months from the date of commissioning. This warranty does not cover any fault, damage or malfunction resulting from:

- a party’s negligence, fault, misuse, abuse, neglect (including lack of or improper maintenance) or incorrect use of the PEFS F3N System;
- fair wear and tear;
- replacement of consumables;
- modification of the PEFS F3N System after it has been installed and commissioned;
- modification of the use, condition and environment of the PEFS F3N System after it has been installed and commissioned;
- use, alteration, repair or maintenance by any party that is not suitably authorised, trained and qualified; or
- vandalism, fire, water, accidental damage, power surge or any other circumstance or event outside of Chubb’s control.

This warranty is conditional upon documented evidence of proper maintenance, performed in accordance with the PEFS F3N Owner’s Manual and Maintenance Manual by qualified and trained personnel, using replacement parts that conform to original design specifications.

Where Chubb breaches its obligations under this warranty, Chubb may in its sole direction elect to re-supply the PEFS F3N System, or to replace or repair the PEFS F3N System.

To the extent permitted by law, Chubb will have no liability for any statements, representations, guarantees, conditions or warranties not expressly stated in writing by Chubb.

Consumer Guarantees

Nothing in this warranty excludes, restricts or modifies the application of the provisions of any statute (including the Competition and Consumer Act 2010 (Cth) and the Australian Consumer Law contained therein) where to do so would contravene that statute or cause any part of this warranty to be void. If the Customer is a “consumer” as defined in the Australian Consumer Law, the following provisions will apply.

Chubb’s products and services come with guarantees that cannot be excluded under the Australian Consumer Law. If the PEFS F3N System is believed to be defective, the Customer must notify Chubb as soon as possible and provide a detailed explanation of the problem.

The Customer is entitled to a replacement or refund for a major failure and to compensation for any other reasonably foreseeable loss or damage. The Customer is also entitled to have the PEFS F3N System repaired or replaced if the PEFS F3N System fails to be of acceptable quality and the failure does not amount to a major failure. Chubb reserves the right to replace any PEFS F3N System under warranty with a new, refurbished or remanufactured PEFS F3N System.

If the failure is not a major failure and Chubb elects to repair the PEFS F3N System:

- goods presented for repair may be replaced by refurbished goods of the same type rather than being repaired. Refurbished parts may be used to repair the goods; and
- if the goods are capable of retaining user-generated data, the repair of the goods may result in the loss of the data.

The benefits given to the Customer under this warranty are in addition to other rights and remedies the Customer has under the Australian Consumer Law and other laws applicable to the products and services. This warranty is provided by Chubb Fire & Security Pty Ltd.

Intended use

The PEFS F3N System is a fire suppression system, installed as part of an overall fire risk reduction strategy, as defined in the fire system specifications and or risk assessment outcomes. As such, it is designed to suppress a fire occurring in the specified risk area only within the documented coverage area of each installed nozzle.

Introduction

Mining, Off-Road, Forestry and Construction equipment operating in harsh outdoor environments can be subjected to the threat of fire at any time. Fire may spread rapidly through the equipment, endangering life and resulting in damage to capital equipment and loss of production. The installation of a fire detection and suppression system is essential to minimise the risk to both operator and equipment.

PEFS F3N is a pre-engineered aspirating foam spray suppression system designed specifically to cope with the harsh operating conditions experienced by mobile and transportable equipment. PEFS F3N systems consist of pressurised cylinders containing fluorine free foam solution, actuation devices to initiate discharge and a discharge network which includes aspirating spray nozzles to direct the foam spray onto the hazard. PEFS F3N systems may be configured for both manual and automatic operation.

PEFS F3N systems offer impressive fire suppression capabilities using **fluorine free** foam through specially designed naturally aspirating spray nozzles that generate an improved foam application over standard foam spray systems. Strategically positioned nozzles direct the aspirated foam spray and provide “three-dimensional” firefighting properties, allowing the system to suppress pressure fires such as might occur from a ruptured fuel or hydraulic line. The air aspirated droplets of foam are extremely efficient at absorbing large amounts of heat and turn to steam which further enhances the three-dimensional firefighting properties of the PEFS F3N system.

MAINTENANCE

General

The following maintenance schedule is a guide and sets out minimum requirements only. All maintenance carried out on the PEFS F3N system should be carried out in accordance with this manual and Australia Standard AS5062. In all cases, local conditions where the system is installed should be taken into consideration when setting maintenance frequencies. For example, in harsh environments the yearly service may need to be carried out every 6 months.

Precautions

Prior to commencing any service activity, the following precautions shall be carried out as applicable:

- (a) Inform the owner or agent that service is to be carried out.
- (b) Where the system may be temporarily impaired, advise the responsible entity of the nature and expected duration of the impairment.
- (c) On equipment that is remotely monitored, advise the monitoring service provider where service activities may cause a signal to be transmitted.
- (d) Disable the system to prevent testing or other service activities from causing discharge of any extinguishing agent.
- (e) Set the detection and alarm system in the appropriate test mode and isolate ancillary facilities to avoid inadvertent operation.
- (f) "Lock-Out" the equipment to prevent its operation and movement whilst performing any maintenance activities in and around the equipment.

On completion of any service, the system shall be restored to its normal operating condition.

Pre-Maintenance Review (Design Survey)

The design survey together with the inspection, test and preventive maintenance regime demonstrates that the fire protection systems or equipment are functional and capable of performing to a standard not less than that to which they were originally designed.

Prior to commencing any maintenance activities, a pre-maintenance review shall be undertaken to determine whether:

- (a) the system will perform as it is intended to as per the documented design at the time of commissioning or recommissioning;
- (b) the date and level of the last scheduled maintenance that has been carried out. Where this cannot be determined, the level of service is to be based from the cylinder date of manufacture.
- (c) neither the fire protection system nor the equipment being protected has changed from the documented system design (baseline data) as of the last commissioning. For example, obstructions to nozzles or fire protection system component changes.

The pre-maintenance review shall include a check against the baseline data, including the approved design for alterations, changes in use or operating environment, or other factors that could adversely affect the performance of the fire protection system.

Any changes to the design of the system including changing the number and or location of nozzles, the number and location of cylinders and or increasing or decreasing the length of discharge pipework shall require a system recommissioning in accordance with the PEFS F3N Design, Installation and Commissioning Manual.

Water Quality

In many areas around Australia, whilst the water may be of drinking quality (potable), it may still contain high levels of chloride salts that make the water unsatisfactory for prolonged contact under pressure in stainless steel cylinders. The presence of salts in water that is used to fill PEFS F3N cylinders may have an impact to the firefighting performance of the foam, can clog the pressure indicator, bind the valve actuation mechanism, inhibit the removal of the cylinder valve and or lead to pitting corrosion of the cylinder.

The maximum limit of chloride ions in water used to fill PEFS cylinders is 150ppm. Only dry nitrogen (not compressed air) shall be used to pressurise PEFS F3N systems.

Where the water quality is in doubt when filling activities are carried out, the use of water from another location source should be used. Failure to do so may result in rapid deterioration of the cylinder assembly, leading to leakage or failure to operate. Routine service shall be undertaken more regularly where:

- (a) water quality has proved to be a problem, or may be likely to be a problem;
- (b) salts are deposited in the cylinder; or
- (c) hard water is used.

System Defects

Defects, including faulty or defective components advised by public notices or manufacturers' service bulletins, shall be replaced, exchanged or repaired.

Critical defects shall be rectified with the minimum of delay. Unless alternative risk reduction measures are implemented for the safety of personnel, equipment shall not be operated until the critical defects are rectified. Critical defects shall be reported to the responsible entity and confirmed in writing within 24 h.

An 'out-of-service' tag system should be used to indicate that the system is temporarily impaired. Tags should be attached to the affected equipment for the duration of the impairment. Evidence of the service level shall not be applied to the service tag or label. The inspection and the outcome shall be entered in the service records.

Non-critical defects shall be rectified as soon as practicable and reported to the responsible entity.

Service Records

A service record at the completion of any scheduled maintenance should be provided to the equipment owner or responsible entity. The service record should contain the following information:

- (a) Service activities.
- (b) Defects.
- (c) Rectifications and by whom.
- (d) Date conducted.
- (e) Where modification to the system has occurred:
 - i. Updated system baseline data or fire system specification
 - ii. System re-commissioning report.

A service tag or label should be provided for each fire protection system to record the last level of inspection, test and survey performed.

The level of service carried out shall be etched, embossed stamped, or indelibly marked on the tag or label in the box corresponding to the year and month in which the routine was performed, with a figure representing the routine as follows:

Punched hole	= commissioned/placed in-service
1	= Six-monthly
2	= Yearly
4	= Five yearly
5	= Recharged after use

The figures shall be not less than 3mm high, and the markings shall be such that the figures are legible.

When a new service label is provided, the label shall be applied adjacent to the completed label so that the previous service history is not obscured.

Recommended Tool List

The following tool list is provided as a guide only.

PEFS F3N Tools

Description	Part Number
Pressurising Rig	87033
Charging Adaptor	130632
Nozzle Cap Tool - Tee Handle	95003
Nozzle Cap Tool - Socket	95004
Over-Fill Tube F3N C23	36210
Over-Fill Tube F3N C30	36211
Over-Fill Tube F3N C45	36212
Over-Fill Tube F3N C65	36213
Over-Fill Tube F3N C106	36214
Over-Fill Tube O-ring	90127

Recommended Common Tools

Description
Tape measure (5m minimum)
Portable tube bender (to suit 12.7mm OD tube)
Flaring tool - 37° (to suit 12.7mm OD tube)
Hand / Drill type deburring tool 2-14mm
Angle grinder 100 mm
Drill (Heavy duty) - 12.7 mm chuck
Drill Set 1mm - 13mm x 0.5mm (high speed)
Socket set - metric 4mm - 19mm, A/F 3/16" - 15/16"
Spanner Set - metric 7mm - 22mm, A/F 1/4" - 1"
Adjustable Spanners 250mm & 450mm
Files - Round and Flat (medium bastard) 250mm
Hex Wrench set (Allen keys) Metric & Imperial
Portable drop saw
Hacksaw
Safety knife
Screwdriver set 13 Piece
Hammer - Ball Pein
Side cutters 250mm
Funnel and measuring jug
Digital scales
Pliers (combination) 225mm
Multigrips 250mm
Cable cutters
Lock-Out devices
Loctite 577 pipe thread sealant or Loctite 569 hydraulic thread sealant
Molykote 111 lubricant or equivalent silicon-based o-ring lubricant.
Loctite C5-A Anti-Seize Lubricant

Table 1 – Recommended Tool List

Service Schedule

The following maintenance schedule is based on the schedule detailed in AS5062 and those requirements applicable to all the hardware and design features detailed in the PEFS F3N Design, Installation and Commissioning manual. The maintenance schedule is ordered in the recommended sequence of maintenance activities for the PEFS LOP System and does not follow the order given in AS5062.

Commencement of the routine service schedule should begin at the completion date of the initial system commissioning. When carrying out the service on an existing installed system where the service history is unknown the Yearly Service Schedule should be performed.

For more detailed maintenance instructions on electrical control systems, panels, detectors and auxiliary electrical devices please refer to their respective product manuals.

Daily Routine Service Schedule

The following daily inspection items should be completed by the operator prior to equipment start-up, shift change or operator change.

Item	Action
System pressure check.	Check all cylinder valves and LOP manual actuator pressure indicators are visible and read within normal range.
Manual actuators	(a) Check that all anti tamper seals and pull pins are in place and secure. (b) Physically check that all manual actuators are secure, clean, undamaged and accessible.
System control and indicating equipment where fitted	(a) Check that all indicators show normal condition. (b) Check that all panels are secure, clean, undamaged and accessible.

Table 2 – Daily Service Schedule

Six-monthly and Yearly Routine Service Schedule

Item No.	Item	Action	6 Mthly	Yearly
1	System pressure check.	Check all cylinder valves and LOP manual actuator pressure indicators are visible and read within normal range.	✓	✓
2	System control and indicating equipment where fitted	(a) Check that all indicators show normal condition. (b) Check that all panels are secure, clean, undamaged and accessible. (c) Test all indicators and audible alarms. (d) Test battery capacity (if fitted)	✓	✓
3	Distribution system	(a) Clean Nozzles and Shrouds. Check nozzle caps are in place and foils are intact. (b) Check nozzles are pointing at pre-determined aiming points. (c) Check distribution system, (hoses, tube, fittings and supports) are intact and not damaged.	✓	✓

Item No.	Item	Action	6 Mthly	Yearly
4	Actuation system	(a) Pneumatic actuation system - Check hoses, manifold blocks, fittings and supports are intact and not damaged. (b) Electric actuation system (if fitted) - Check wiring, connections and supports are intact and not damaged.	✓	✓
5	Manual actuators	(a) Check that all anti tamper seals and pull pins are in place and secure. (b) Physically check that all manual actuators are secure, clean, undamaged and accessible. (c) Test operation.	✓	✓
6	Detection system	(a) Pneumatic detection system (LOP Tubing) - Check detection hoses, LOP tubing, fittings and supports are intact and not damaged and are in position. (b) Electric detection system (if fitted) - Check detectors, wiring, connection and supports are in intact, not damaged and detectors are in position.	✓	✓
7	Storage containers	(a) Check cylinders and valves are not damaged. (b) Check cylinders and mounting brackets are secure.	✓	✓
8	System Labels	Check Cylinder, LOP Manual Actuator and system warning and instruction labels are securely in place, visible and legible.	✓	✓
9	Discharge test (optional)	(a) Conduct discharge test and record result (b) Check fire suppression system nozzle area coverage.		✓
10	Storage containers	(a) Remove cylinder and inspect mounting bracket and cylinder for damage and condition. (b) Check date of test or manufacture on storage container. If over 5 years old – subject the cylinder to an inspection and hydrostatic pressure test in accordance with AS 2030.5 and AS2337.1		✓
11	Container valves	Service and lubricate the LOP Valves		✓
12	Extinguishing agent solution	Replace foam solution in cylinders		✓
13	Distribution system	Conduct clear passage test using dry nitrogen and physically check distribution system, (i.e. that hoses, tube, fittings and supports are secure).		✓
14	Mechanical actuator	Service and lubricate the LOP Manual Actuators		✓
15	Detection system - Pneumatic	Pneumatic detection system (LOP Tubing): (i) replace the LOP Detection Tubing (ii) test pneumatic circuits for leaks (iii) check hoses, LOP tubing, fittings and supports are secure		✓
16	Actuation system – Pneumatic	(a) test pneumatic circuits for leaks (b) check hoses, manifold blocks, fittings and supports are secure		✓

Item No.	Item	Action	6 Mthly	Yearly
17	Actuation system – Electrical (where fitted)	(a) Function test all actuation circuits. Ensure LOP Electric Actuator opens and closes correctly. (b) check all wiring for earths (c) check wiring, connections and supports are secure		✓
18	Detection system - Electrical (where fitted)	Electric detection system (if fitted) (i) function test all detectors (ii) check all wiring for earths (iii) check wiring, connections and supports are secure		✓
19	System interface and shutdown (where fitted)	Test all fire suppression system activated equipment shutdowns and record delay time.		✓
20	Nozzle obstructions	Check for adequate clear space at nozzles and for obstructions likely to impede discharge.		✓
21	Nozzle location and coverage	Check for the introduction of fixtures and bulkheads shielding nozzle discharge and the presence of unprotected hazard areas, particularly where a source of fuel and heat exists.		✓
22	Detector coverage	Check for the presence of unprotected hazard areas, particularly where a source of fuel and heat exists.		✓
23	Operational conditions	Check that the detector response and extinguishing agent discharge or retention will not be adversely affected by such things as enclosure openings, ventilation airflows or high temperature protected areas.		✓
24	Environmental conditions	Check that the fire system and its components are suitable for the environmental conditions in which the machine is operating, e.g. that components are suitable for underground mining, and road gradient and slopes are within container orientation limits.		✓
25	Survey	Complete review of system to confirm it is in accordance with the approved design and no changes have been made which would impair performance.		✓

Table 3 – Six-monthly and Yearly Service Schedule

Six Monthly Service Instructions

System pressure check (Item 1)

1. Check the reading on the pressure indicator located on the cylinder valve of each cylinder assembly installed. The pressure should read within the green and yellow segments of the indicator.
2. Check the reading on the pressure indicator located on each LOP manual actuator installed. The pressure should read within the green and yellow segments of the indicator.
3. If system is low on pressure, the source of the leak should be identified and rectified prior to re-pressurising the system.
4. If the system pressure shows OkPa, it is likely the system has been discharged and will need to be refilled.
5. If a pressure indicator reads differently to all of the other pressure indicators, this pressure indicator is most likely faulty or out of calibration. Replace the faulty pressure indicator. Refer to section on valve service and actuator service located later in this manual.

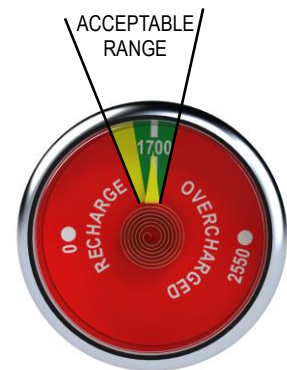

Figure 1

System control and indicating equipment [where fitted] (Item 2)

Note: Refer to Control System / Panel product manuals for detailed operational and maintenance requirements.

1. Check that all indicators show normal condition:
 - a. Power on indicator light illuminated
 - b. Fault indicators are not illuminated
 - c. System Discharge indicators are not illuminated
 - d. Fire Alarm indicators are not illuminated
 - e. System Isolation indicators are not illuminated
 - f. Audible alarms not sounding
2. Set control panel (where applicable) to its "Isolation / Test" mode.

⚠ WARNING: System Control Panels must remain in there "Isolation / Test" mode during the remainder of the scheduled maintenance activities to prevent accidental discharge of the system.

3. Check that all status indicators and audible alarms function correctly.
4. Check that all panels are secure, clean, undamaged and accessible.
5. Test battery capacity (if fitted).

Distribution system (Item 3)

1. Clean Nozzles and Shrouds.
2. Check nozzle caps are in place and foils are intact. Replace foil caps if required.
 - a. Foil Caps should only be fitted and removed using the Nozzle Cap Tool. The recommended torque setting is 4-5Nm.
 - b. Always screw on the Foil Caps by hand for the first couple of turns before using the Nozzle Cap Tool to tighten the cap to prevent cross threading.
3. Check nozzles are pointing at pre-determined aiming points. Refer to system design data (baseline data) as of last commissioning.
4. Check distribution system is intact and not damaged:
 - a. Hoses are not worn, split, cut or kinked.
 - b. Hoses have protective sleeves fitted along locations where rubbing can occur.
 - c. Tubing is not dented, kinked or otherwise damaged
 - d. Fittings do not show signs of excessive corrosion
 - e. Fittings are secure.
 - f. Clamps are adequately secured to the equipment and firmly hold the discharge hoses and or tubing in place.
 - g. Nozzle brackets (where fitted) are adequately secured to the equipment and firmly holds the nozzle kit fittings.

Actuation system (Item 4)

1. Check pneumatic actuation system is intact and not damaged:
 - a. Hoses are not worn, split, cut or kinked.
 - b. Hoses have protective sleeves fitted along locations where rubbing can occur.
 - c. Fittings do not show signs of excessive corrosion
 - d. Fittings are secure
 - e. Manifold block is adequately secured to the equipment.
 - f. Clamps are adequately secured to the equipment and firmly hold the actuation hose in place.
2. Check electric actuation system (if fitted) is intact and not damaged:
 - a. Electrical cabling is not worn, split, cut or kinked.
 - b. Electrical cabling has protective sleeves fitted along locations where rubbing can occur.
 - c. Electrical connectors are intact and not damaged.
 - d. Separate connectors and check to ensure they are free from ingress of dirt, water and corrosion. Replace if required. Re-connect all electrical connectors.
 - e. All cabling clamps and supports are adequately secured to the equipment and firmly holds the cabling in place.

Manual Actuators (Item 5)

⚠ WARNING: The cylinder and actuation pipework contains high pressure. Do not remove any parts from the cylinder or actuation pipework unless it is depressurised first.

Note: The LOP Manual actuators are designed to “fail to safe”. That is any fault causing leakage will activate the system. As such the LOP Manual actuators may be considered operational if the below listed checks are carried out.

1. Check that all actuators are intact and not damaged.
2. Check that all actuators are accessible and access has not been restricted by equipment modification.
3. Check that all pull pins and security ties (anti tamper seals) are in place and secure. Replace security ties if missing or broken.
4. Check that the pull pin retainer wire is correctly securing the pull pin to the actuator.
5. Check to ensure pressure is reading in the green sector of the pressure indicator
6. Remove the front housing cover and check that all actuators are:
 - a. Clean and undamaged.
 - b. Foil is intact on outlet port nozzle. Replace if required.
 - c. Schrader Valve has cap fitted to protect against ingress of dust and dirt.
7. Check that all actuators are adequately secured to the equipment.
8. Leak Test all connection points (refer figure below) with a liquid leak detection solution. If actuator shows any signs of leakage, carry out service on actuator.

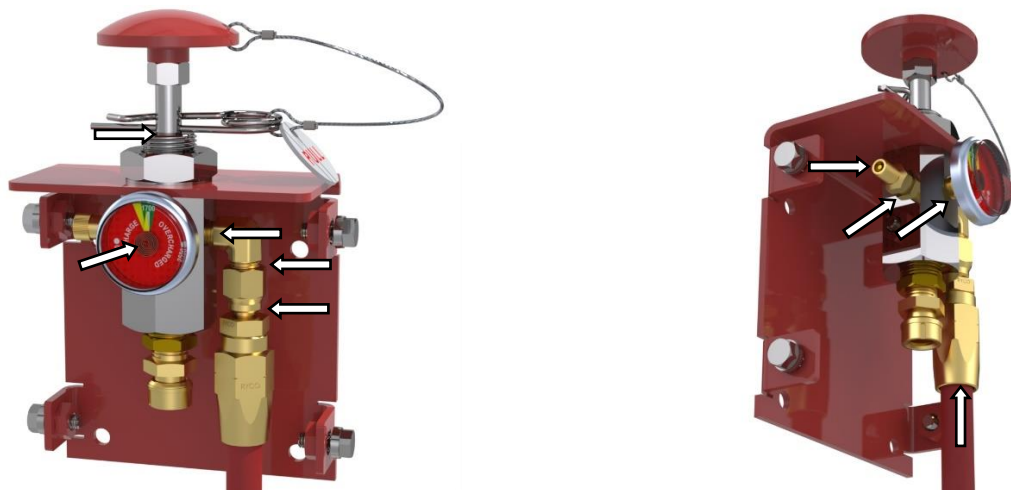

Figure 2

9. Re-fit housing cover and ensure it is securely bolted on and label is intact and readable.

Detection System (Item 6)

⚠ WARNING: The cylinder and actuation pipework contains high pressure. Do not remove any parts from the cylinder or actuation pipework unless it is depressurised first.

1. Check LOP Tubing is intact and not damaged:
 - a. LOP Tubing is not worn, split, cut or kinked.
 - b. LOP Tubing is located in correct position. Refer to system design data (baseline data) as of last commissioning.
 - c. Check to ensure any modifications to equipment has not subjected LOP Tubing to possible heat exposure greater than 90°C.
 - d. Fittings do not show signs of excessive corrosion.
 - e. Fittings are secure.
 - f. Clamps are adequately secured to the equipment and firmly hold the LOP Tubing in place.
2. Check electric detection system (if fitted) is intact and not damaged:
 - a. Electrical cabling is not worn, split, cut or kinked.
 - b. Electrical cabling has protective sleeves fitted along locations where rubbing can occur.
 - c. Electrical connectors are intact and not damaged.
 - d. Separate connectors and check to ensure they are free from ingress of dirt, water and corrosion. Replace if required. Re-connect all electrical connectors.
 - e. All cabling clamps and supports are adequately secured to the equipment and firmly holds the cabling in place.
 - f. Detector locations are in correct position. Refer to system design data (baseline data) as of last commissioning.

Storage containers (Item 7)

1. Check all cylinder valves are not damaged.
2. Check all cylinder burst disk assemblies are not damaged. Use of a vinyl protective cap over the burst disk assembly is recommended to prevent ingress of dirt and wear on the burst disk surface.
3. Visually inspect exterior of all installed cylinders. Where a cylinder is dented, scored, pitted or otherwise damaged by corrosion and it cannot be determined if the damage is within the limits as detailed in AS 2337.1, then the cylinder shall be condemned.
4. Check the manufacture date and or last pressure test date of all installed cylinders. If this exceeds five years then the cylinder will require an inspection and hydrostatic test in accordance with AS2030.5 and AS2337.1.
5. Check cylinders and mounting brackets are secure.

System Labels (Item 8)

Check Cylinder, LOP Manual Actuator and system warning and instruction labels are securely in place, visible and legible.

After Maintenance Activities

After the 6 monthly maintenance activities have been completed:

1. Ensure all pressure indicators are reading in the green and yellow zone.
2. Ensure control panel (where fitted) is reset to its normal operation mode and is no longer in its "Isolation / Test" mode.
3. Complete routine service records in accordance with AS5062
4. Stamp Service Tag with the number "1" in the corresponding Year/Month location.

Yearly Service Instructions

Discharge Test [Optional] (Item 9)

An annual discharge test can be used to confirm the complete PEFS F3N system operates and performs as that intended as when originally commissioned.

Please refer to the Chubb PEFS F3N Foam Concentrate SDS prior to carrying out the Discharge Test. Discharge of foam solution must be handled according to national or local waste regulations. Permission must be granted from the site representative before carrying out the discharge test.

1. Check system pressure is reading in the green and yellow sector on the pressure indicators located on the cylinder valves and manual actuators.
2. Discharge the PEFS system using the furthest located LOP manual actuator
3. Confirm all nozzles discharge and produce conical spray pattern.
4. Check that the nozzle discharge patterns cover the fire hazard area as specified in the commissioning documentation.
5. Check that all monitoring and control panel alarms, shutdown and ancillary functions operate as intended
6. Record the Effective Discharge Time (EDT) and compare it to the EDT recorded during commissioning.

Storage containers (Item 10)

1. Remove discharge hose (3) from cylinder valve (4).
2. Fit end cap to discharge outlet port to prevent accidental discharge.
3. Remove Schrader valve cap from filler plug assembly (1).
4. Depress Schrader valve core to release cylinder pressure.
5. Check that the pressure indicator on LOP Cylinder Valve (4) shows 0kPa.
6. Reinstall Schrader valve cap.
7. Remove actuation hose (2) from top of cylinder valve (4).
8. Remove filler port assembly (1).
9. Remove foam solution from the cylinder.
10. Check all cylinder burst disk assemblies are not damaged. Use of a vinyl protective cap over the burst disk assembly is recommended to prevent ingress of dirt and wear on the burst disk surface.
11. Visually inspect exterior of all installed cylinders. Where a cylinder is dented, scored, pitted or otherwise damaged by corrosion and it cannot be determined if the damage is within the limits as detailed in AS 2337.1, then the cylinder shall be condemned.
12. Visually inspect interior of all installed cylinders. Where a cylinder is damaged by corrosion and it cannot be determined if the damage is within the limits as detailed in AS 2337.1, then the cylinder shall be condemned.
13. Check the manufacture date and or last pressure test date of all installed cylinders. If this exceeds five years then the cylinder will require an inspection and hydrostatic test in accordance with AS2030.5 and AS2337.1.
14. Check brackets are not damaged and secure.
15. Re-fit and secure cylinders into brackets.



Figure 3

Cylinder Valve – Service (Item 11)

WARNING: The cylinder is a pressure vessel. Do not remove any parts from the cylinder prior to depressurising the cylinder.

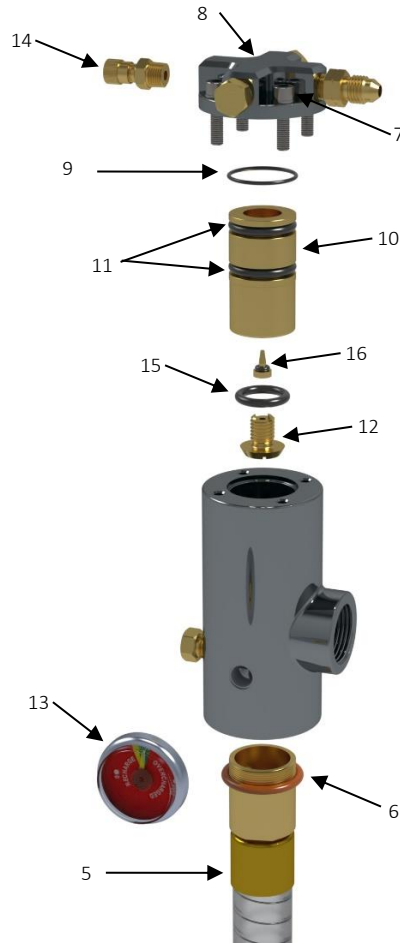

Figure 4

A Valve Service Kit (Part No: 28037) is available for the purpose of servicing the LOP valve.

1. Remove cylinder valve (4) from cylinder.
2. Remove Syphon Tube (5) and Cylinder Neck O-ring (6)
3. Remove the 4 screws and washers (7).
4. Remove the cap (8) and o-ring (9).
5. Remove the piston assembly (10).
6. Inspect and clean piston o-rings (11) and sealing o-ring (15). Replace if they show signs of wear or damage. Check to ensure check valve (16) moves freely inside piston, clean and or replace if required. Lubricate outside diameter o-rings (11) and outside diameter of piston assembly (10) with Molykote 111. Do not lubricate sealing o-ring (15) and check valve o-ring (16). If retainer (12) was removed, re-fit using Loctite 569 or Loctite 577 on thread.
7. Clean inside of valve. Check for scratches and scoring. Re-install piston assembly (10).
8. Inspect and clean o-ring (9) and replace if it shows signs of wear or damage. Lubricate o-ring (9) with Molykote 111 and fit to cap (8).
9. Re-install cap (8), washers and screws (7) to cylinder valve.
10. Inspect syphon tube (5). Replace if tube has become stiff or is damaged.
11. Inspect and clean Cylinder Neck O-ring (6) and replace if it shows signs of wear or damage. Lubricate with Molykote 111.
12. Inspect and clean Pressure Indicator (13) and Schrader Valve (14). Replace if faulty or damaged. Use Loctite 577 or Loctite 569 on threads
13. Re-install cylinder valve (4) to cylinder.

Additional requirements if LOP Valve Actuation Bypass is installed:

1. Remove hose assembly (17) from filler plug assembly (1)
2. Remove filler plug assembly (1) from cylinder
3. Unscrew retainer (18) and remove check valve (19)
4. Inspect and clean oring (20) and check valve oring (21). Replace if they show signs of wear or damage. Do not lubricate check valve o-ring (21).
5. Re-fit retainer (18) using Loctite 569 or Loctite 577 on thread.

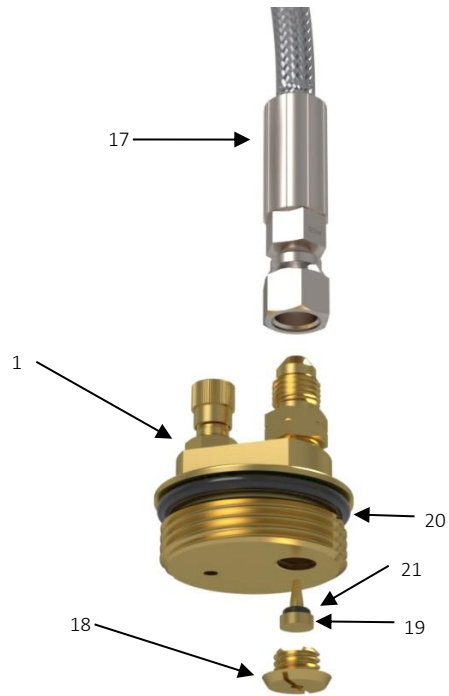

Figure 5

Cylinder Refilling (Item 12)

⚠ WARNING: The cylinder is a pressure vessel. Do not remove any parts from the cylinder prior to depressurising the cylinder.

Cylinders must only be filled with clean potable water (chloride ion content <150ppm). The fill quantities for each size cylinder are detailed in the table below.

Please refer to the Chubb PEFS F3N Foam Concentrate SDS prior to handling the foam concentrate.

Cylinder Size	Total Fill	Water quantity	Foam quantity	Fill Kit Part No.
C23 cylinder assembly	18 lt.	17 lt.	1 lt.	51015
C30 cylinder assembly	24 lt.	22.5 lt.	1.5 lt.	51016
C45 cylinder assembly	35 lt.	33 lt.	2 lt.	51017
C65 cylinder assembly	50 lt.	47 lt.	3 lt.	51018
C106 cylinder assembly	85 lt.	80 lt.	5 lt.	51019

Table 4 Cylinder Filling Volumes

1. Remove Filler Plug Assembly.
2. Filling by Scales:
 - a. Remove Over-fill tube (if fitted) from filling port.
 - b. Fill cylinder with water to required volume as per Table 4 Cylinder Filling Volumes.
 - c. Add complete contents of foam from the Filling Kit.
3. Filling by Over-fill tube (LOP valve must be fitted to cylinder in closed position):
 - a. Ensure Over-fill tube is correctly seated in filling port.
 - b. Add water to cylinder slowly until it initially over-flows. (Do not insert water supply hose below the bottom of the Over-fill tube.)
 - c. Remove Over-fill tube from filling port.
 - d. Add complete contents of foam from the Filling Kit.
4. Refit Filler Plug Assembly.

Distribution System – Clear Passage Test (Item 13)

1. Disconnect discharge hose from cylinder valve.
2. Remove Nozzle Foil Caps from nozzles.
3. Flush discharge network with water and/or compressed air/nitrogen
4. Check distribution network is clear of any blockages
5. Clean Nozzles and Shrouds.
6. Re-fit Nozzle Foil Caps. Replace foil caps if required.
 - a. Foil Caps should only be fitted and removed using the Nozzle Cap Tool. The recommended torque setting is 4-5Nm.
 - b. Always screw on the Foil Caps by hand for the first couple of turns before using the Nozzle Cap Tool to tighten the cap to prevent cross threading.
7. Check nozzles are pointing at pre-determined aiming points. Refer to system design data (baseline data) as of last commissioning.
8. Check distribution system is intact and not damaged:
 - a. Hoses are not worn, split, cut or kinked.
 - b. Hoses have protective sleeves fitted along locations where rubbing can occur.
 - c. Tubing is not dented, kinked or otherwise damaged
 - d. Fittings do not show signs of excessive corrosion
 - e. Fittings are secure.
 - f. Clamps are adequately secured to the equipment and firmly hold the discharge hoses and or tubing in place.
 - g. Nozzle brackets (where fitted) are adequately secured to the equipment and firmly holds the nozzle kit fittings.

Manual Actuators – Service (Item 14)

WARNING: Do not loosen any hose connections or fittings in the LOP actuation system while the system is pressurised. This will cause the system to discharge. Prior to servicing any LOP actuators ensure the system is depressurised by depressurising the PEFS F3N cylinders using the Schrader valve fitted to the cylinder Filler Plug Assembly. Ensure pressure indicators on manual actuator reads zero pressure.

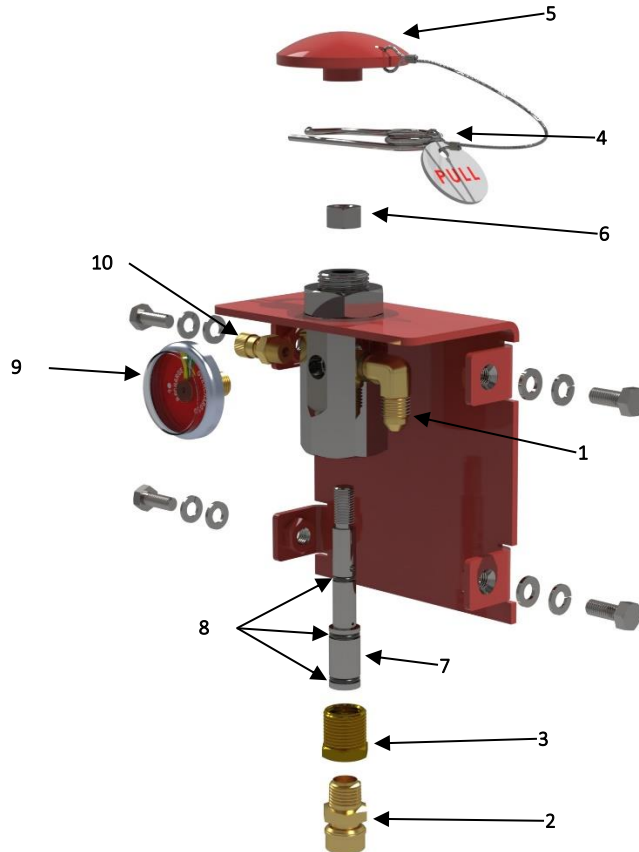

Figure 6

A LOP Actuator Service Kit (Part No: 28038) is available for the purpose of servicing the LOP manual actuator.

1. Remove the actuator cover plate.
2. Remove actuation hose from actuator connection (1).
3. Remove Foil Nozzle (2) and Adaptor (3)
4. Check the Foil Nozzle (2) to ensure its foil seal is intact and not damaged or ruptured. Replace if required.
5. Remove Pull Pin (4)
6. Remove Push Button (5) and Nut (6)
7. Remove valve piston assembly (7) from valve body.
8. Inspect and clean piston o-rings (8) and replace if they show signs of wear or damage. Lubricate using Molykote 111.
9. Refit valve piston assembly (7) to valve body
10. Ensure that the actuation mechanism moves freely.
11. Refit Nut (6) and Push Button (5). Tighten nut up against Push Button.
12. Refit Pull Pin (4)
13. Refit Adaptor (3) and Foil Nozzle (2). Use Loctite 577 or Loctite 569 on threads
14. Inspect and clean Pressure Indicator (9) and or Schrader Valve (10). Replace if faulty or damaged. Use Loctite 577 or Loctite 569 on threads
15. Reconnect actuation hose to actuator connection (1).

Detection system – Pneumatic (Item 15)

⚠ WARNING: Do not loosen any hose connections or fittings in the LOP actuation system while the system is pressurised. This will cause the system to discharge. Prior to replacing any LOP detection tubing ensure the system is depressurised by depressurising the PEFS F3N cylinders using the Schrader valve fitted to the cylinder Filler Plug Assembly.

After having depressurised the PEFS F3N system:

1. Replace each length of LOP detection tubing.
2. Ensure LOP tubing does not kink.
3. Check LOP tubing is located in correct position. Refer to system design data (baseline data) as of last commissioning.
4. Check to ensure any modifications to equipment has not subjected LOP tubing to possible heat exposure greater than 90°C.
5. Check LOP tubing fittings do not show signs of excessive corrosion.
6. Check LOP tubing fittings are secure.
7. Check LOP tubing clamps are adequately secured to the equipment and firmly hold the LOP tubing in place.

Actuation system – Pneumatic (Item 16)

Check pneumatic actuation system is intact, not damaged and free of any blockages:

1. Hoses are not worn, split, cut or kinked.
2. Hoses have protective sleeves fitted along locations where rubbing can occur.
3. Fittings do not show signs of excessive corrosion
4. Fittings are secure
5. Manifold block is adequately secured to the equipment.
6. Clamps are adequately secured to the equipment and firmly hold the actuation hose in place.
7. Carry out clear passage test with compressed air or nitrogen on each run of actuation hose.

Actuation system – Electrical [where fitted] (Item 17)

Note: The following maintenance activities should be carried out in conjunction with the listed fire control system manuals.

1. Check electric actuation system is intact and not damaged:
 - a. Electrical cabling is not worn, split, cut or kinked.
 - b. Electrical cabling has protective sleeves fitted along locations where rubbing can occur.
 - c. Electrical connectors are intact and not damaged.
 - d. Separate connectors and check to ensure they are free from ingress of dirt, water and corrosion. Replace if required. Re-connect all electrical connectors.
 - e. All cabling clamps and supports are adequately secured to the equipment and firmly holds the cabling in place.
2. Function test all actuation circuits. Ensure each LOP Electric Actuator opens and closes correctly.
3. Check all wiring for earths

Detection system - Electrical [where fitted] (Item 18)

Note: The following maintenance activities should be carried out in conjunction with the listed fire control system manuals.

1. Check electric detection system is intact and not damaged:
 - a. Electrical cabling is not worn, split, cut or kinked.
 - b. Electrical cabling has protective sleeves fitted along locations where rubbing can occur.
 - c. Electrical connectors are intact and not damaged.
 - d. Separate connectors and check to ensure they are free from ingress of dirt, water and corrosion. Replace if required. Re-connect all electrical connectors.
 - e. All cabling clamps and supports are adequately secured to the equipment and firmly holds the cabling in place.
 - f. Detector locations are in correct position. Refer to system design data (baseline data) as of last commissioning.
2. Function test all detectors
3. Check all wiring for earths

System interface and shutdown [where fitted] (Item 19)

Note: The following maintenance activities should be carried out in conjunction with the listed fire control system manuals.

Test all fire suppression system activated equipment shutdowns and record delay time.

System Pressurising

LOP systems are pressurised using the Schrader valve fitted on top of the LOP Valve Assembly or using the Schrader valve fitted on the manual LOP actuators.

 **WARNING:** Do not pressurise a cylinder that is not in test date.

NOTE: Do not pressurise LOP systems using the Schrader valve on the filler port assembly of the PEFS cylinders. This will cause the cylinder to discharge.

1. Cap the discharge port of each cylinder valve to prevent solution loss in the event of an accidental discharge.
2. Check to ensure that all electrical actuation devices have been isolated.
3. Connect a regulated source of nitrogen through an approved charging rig (refer Figure 7) to either:
 - a. the cylinder valve assembly charging point
 - b. the charging point on one of the LOP manual actuators
4. Pressurise the system to the correct listed pressure as per Table 5 **Error! Reference source not found.**
5. Hold pressure for a minimum of 1 minute. Increase this time for each additional cylinder.
6. Check the pressure indicator on the cylinder valve and ensure it is in the green zone.
7. Shut off supply at the control valve and unscrew the charging adaptor (internal)
8. Vent pressure from the charging rig prior to disconnecting adaptor then disconnect the pressure source.
9. Test the actuation system for leaks. Leak testing should be carried out using a liquid leak detection solution.
 - a. Leak test all fitting connections
 - b. Leak test all LOP Manual actuators (refer above under 6 Monthly Service Instructions)
 - c. Leak test all LOP Electrical Solenoid Valve Assemblies
10. Test the cylinder for leaks. Leak testing should be carried out using a liquid leak detection solution.
 - a. Leak test filler port
 - b. Leak test burst disk
 - c. Leak test all ports on the LOP Valve assembly
 - d. Leak test cylinder welds.
11. Remove caps from discharge ports and re-fit distribution hoses.

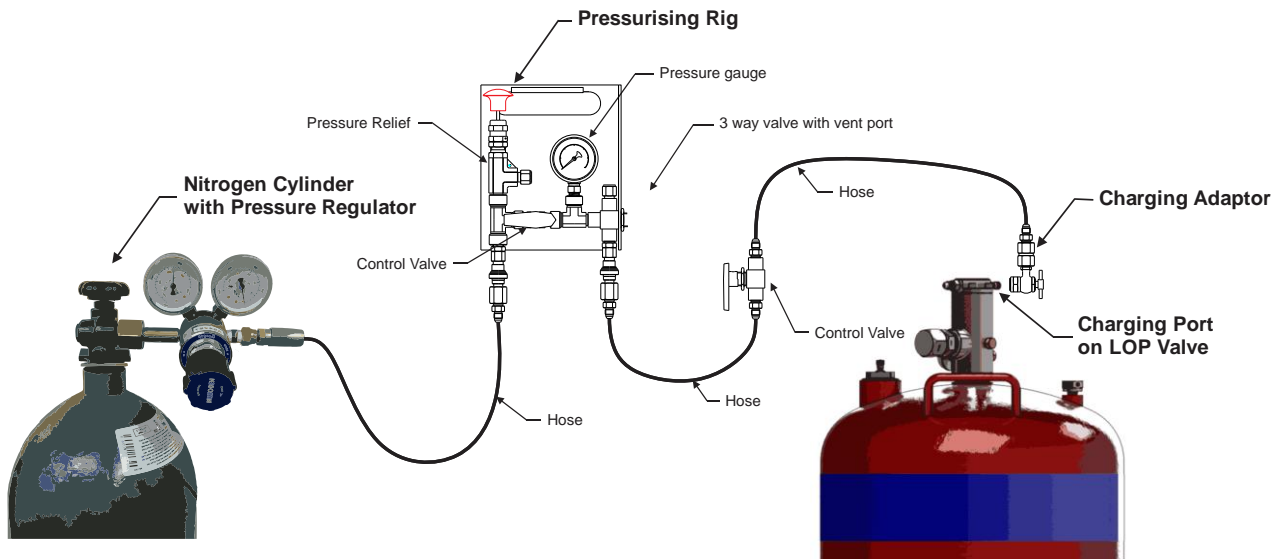

Figure 7 – Typical Pressurising Rig

Ambient Temperature (°C)	Charge Pressure (kPa)
5	1602
10	1633
15	1663
21	1700
25	1725
30	1755
35	1786
40	1816
45	1847
50	1878

Table 5 - PEFS F3N cylinder charging pressure versus ambient temperature

After Maintenance Activities

After the Yearly maintenance activities have been completed:

1. Ensure all pressure indicators are reading in the green zone.
2. Ensure all labels are in good condition (refer 6 monthly service item 8)
3. Ensure control panel (where fitted) is reset to its normal operation mode and is no longer in its "Isolation / Test" mode.
4. Ensure panel status lights are in normal condition (refer 6 monthly service item 2)
5. Complete routine service records in accordance with AS5062
6. Stamp Service Tag with the number "2" in the corresponding Year/Month location.

MAINTENANCE REPORT

Inspection and Maintenance Report for PEFS F3N Vehicle Fire Suppression System

Work Order Number: _____ Date: _____

Client Information

Customer Name: _____ Contact Name: _____
 Customer Address: _____
 Telephone: _____ Mobile: _____ Fax: _____

Equipment Information

Equipment Type: _____ Equipment Make: _____
 Equipment Model: _____ Equipment Serial No.: _____
 Equipment Location: _____

System Information

Cylinder Size: _____ Qty: _____ Serial Numbers: _____ Manufacture Date: _____
 Qty Nozzles: _____ Qty Manual Actuators: _____ Fire Alarm Panel: Standard Shutdown None

Service

Item	Service	6 Mthly	Yrly	Defect Report
1	System Pressure – Check			
2	System control and indicating equipment - Check			
3	Distribution system – Check			
4	Actuation system – Check			
5	Manual LOP Actuators – Check			
6	Detection system – Check			
7	Storage containers – Check			
8	System Labels - Check			
9	Discharge Test <i>[optional]</i>			Discharge Time:
10	Storage containers - Inspect			
11	Container valves - Service			
12	Extinguishing agent solution - Replace			
13	Distribution system - Test			
14	Mechanical actuator - Service			
15	Detection system (Pneumatic) – Check & Test			
16	Actuation system (Pneumatic) – Check & Test			
17	Actuation system (Electrical) <i>[where fitted]</i> – Check & Test			
18	Detection system (Electrical) <i>[where fitted]</i> – Check & Test			
19	System interface and shutdown <i>[where fitted]</i> –Test			
20	Nozzle obstructions – Check			
21	Nozzle location and coverage – Check			
22	Detector coverage – Check			
23	Operational conditions – Check			
24	Environmental conditions – Check			
25	Survey - Review			

Record of all repairs: _____

Record of parts used: _____

Does system meet original Design Specifications: YES NO

If No, Changes: _____

Name of Technician: _____ Signature: _____

Name of Customer: _____ Signature: _____

SPARE PARTS

Cylinder Assemblies & Brackets

Cylinders Assemblies



Figure 8

Cylinder Assembly Details:

Part Number	109508	109510	109511	109512	111045
Description	C23 Cylinder	C30 Cylinder	C45 Cylinder	C65 Cylinder	C106 Cylinder
Water Capacity	23 lt.	30 lt.	45 lt.	65 lt.	106 lt.
Height (mm)	726	512	572	772	1188
Height with Valve	960	740	820	1020	1440
Diameter (mm)	216	318	360	360	360
Design Registration	V1061-84 / V1301719	V881-82 / V1301721	V376-84 / V1301718	V376-84 / V1301718	V376-84 / V1301718
Test Pressure	6 MPa / 3.3 MPa	3.3 MPa / 3.3 MPa	3.6 MPa / 3.3 MPa	3.6 MPa / 3.3 MPa	3.6 MPa / 3.3 MPa
Total Fill	18 lt.	24 lt.	35 lt.	50 lt.	85 lt.
Water quantity	17 lt.	22.5 lt.	33 lt.	47 lt.	80 lt.
Foam quantity	1 lt.	1.5 lt.	2 lt.	3 lt.	5 lt.
Pressure @ 21°C	1700 kPa	1700 kPa	1700 kPa	1700 kPa	1700 kPa
Empty Mass (incl Valve Assy)	10.9 kg	12.1 kg	13.5 kg	17.6 kg	24.3 kg
Gross Mass (incl Fill)	28.9 kg	36.1 kg	48.5 kg	67.6 kg	109.3 kg
Total Mass (incl Fill & Bracket)	38.9 kg	45.5 kg	65.5 kg	84.6 kg	134 kg

Table 6 - PEFS F3N cylinder specifications

Item	Part Number	Description
1	112255	Burst Disk
2	23100	Filler Plug Assembly
3	90127	Filler Port O-Ring
4	60328	Label – Blue Identification Band C30 & C45 Cylinders
	60329	Label – Blue Identification Band C23 & C65 Cylinders
	60330	Label – Blue Identification Band C106 Cylinder
5	66141	Label – Main PEFS F3N Cylinder Label

Table 7 – Cylinder Assembly Parts

LOP Cylinder Valve



Figure 9 – LOP Valve Assembly

Part Number	Description
26023	PEFS LOP Valve Assembly
28037	PEFS LOP Valve Service Kit

Table 8 – Valve Assembly

Siphon Tubes



Figure 10 – Siphon tube

Cylinder Size	Siphon Tube Part Number	Syphon Tube Length (±2mm)
C23	109298	719
C30	110281	485
C45	110282	546
C65	110283	745
C106	112040	1156

Table 9 – Siphon tube details

Fill Kits

Cylinder Size	Fill Kit Part Number
C23	51015
C30	51016
C45	51017
C65	51018
C106	51019



Table 10 – Fill Kits

Over-fill Tubes

Cylinder Size	Part Number	Length (mm)
C23	36210	175
C30	36211	125
C45	36212	138
C65	36213	194
C106	36214	296



Table 11 – Over-fill tube details

Cylinder Brackets

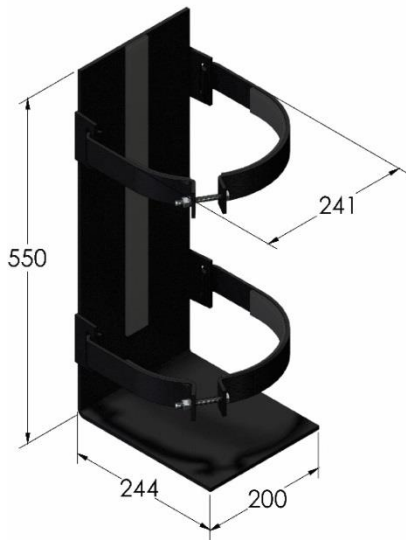

Figure 11 – C23 Cylinder Bracket
(part number 128735)

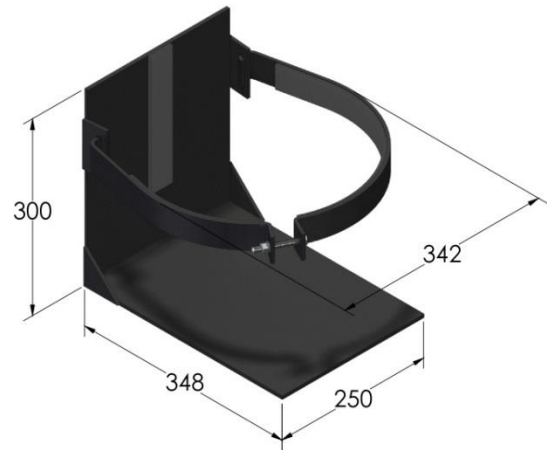

Figure 12 – C30 Cylinder Bracket
(part number 128736)

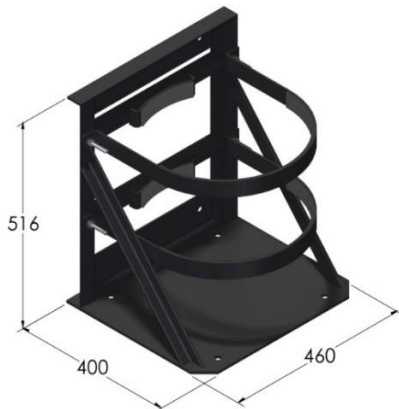

Figure 13 – C45 & C65 Cylinder Bracket
(part number 128737)

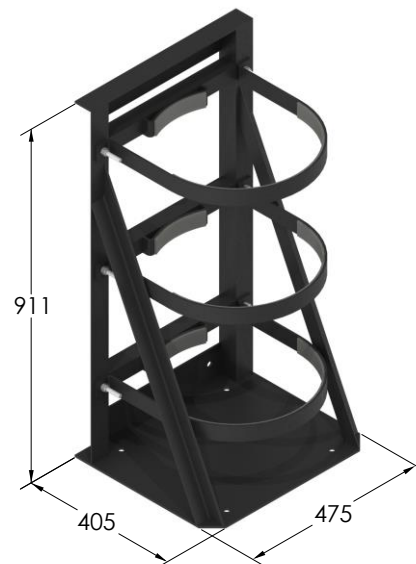

Figure 14 – C106 Cylinder Bracket
(part number 128738)

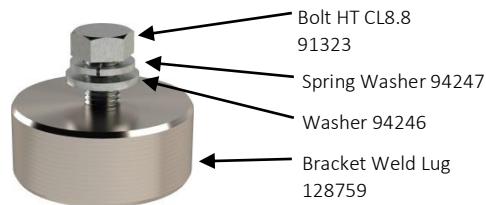

Figure 15 – Bracket Weld Lug Assembly

LOP Valve Actuation Bypass Kit (Optional)

Item	Part Number
LOP Valve Bypass Kit (complete)	28059
Piston Assembly Bypass	24003
Filler Plug Assembly Bypass	23104
S/S Braided Hose	46032
Tee 7/16" JIC m/f/m	72025
Nipple 1/8" NPT x 7/16" JIC	72018



Table 12 LOP Valve Actuation Bypass Kit Parts

Discharge Components

Stainless Steel Tube

Part Number 112108 (2m lengths).

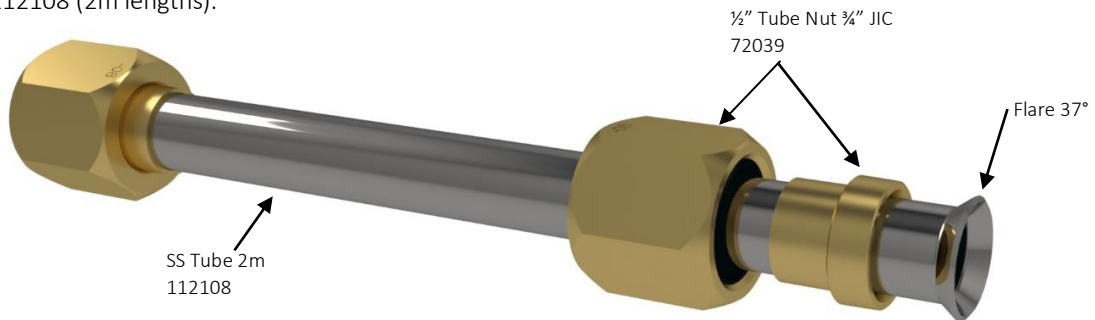

Figure 16 – Stainless steel tube and fittings

Discharge Hose

	Hose Size	Part Number	Minimum Bend Radius	Temperature Rating (Air/Water)
	1/2"	118097	180mm (7")	-40°C – 71°C
3/4"	118098	240mm (9.5")		

Table 13 – Discharge hose

Nozzles

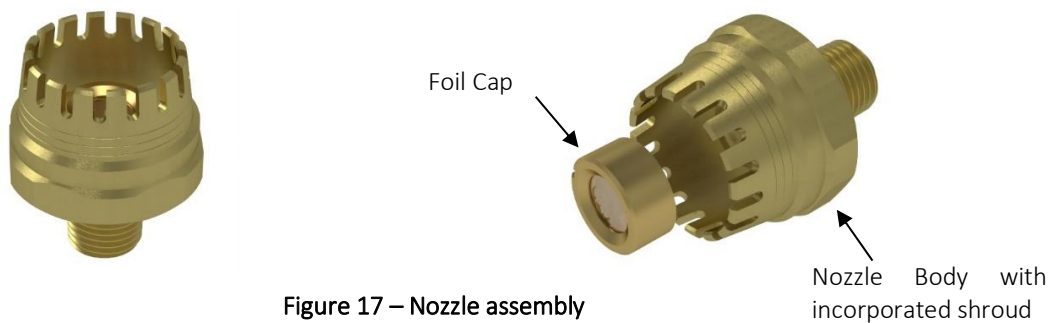

Figure 17 – Nozzle assembly

Part Number	Description
46128	Nozzle brass 3/4" BSP 1-piece c/w Foil Cap
46129	Replacement Foil Cap

Table 14 Nozzle Parts

Nozzle Kits

Nozzle kit single straight (part number 72008)



Nozzle kit single end 90° (part number 72031)



Nozzle kit single straight 90° (part number 72400)



Nozzle kit single end 45° (part number 72033)



Nozzle kit double straight 90° (part number 72403)



Nozzle kit double straight 90°/45° (part number 72404)

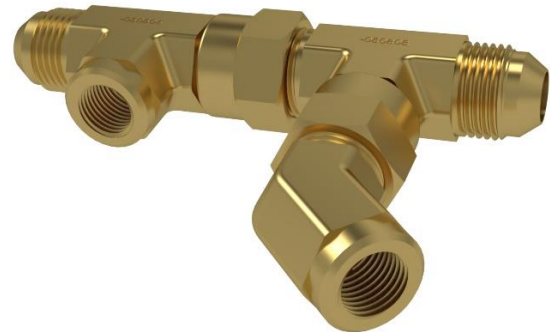

Nozzle kit 1/4" BSP for Bracket (part number 115815)

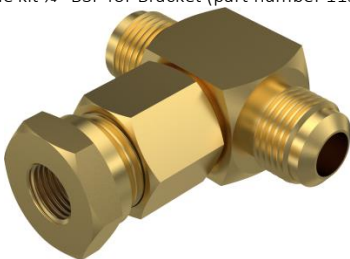



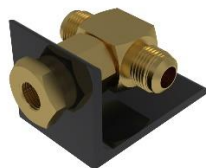
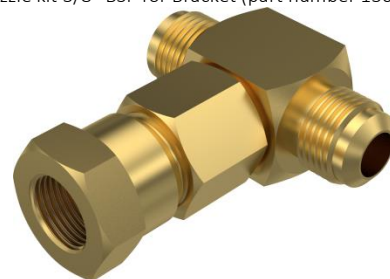









Nozzle kit 3/8" BSP for Bracket (part number 130104)

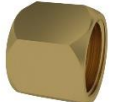

Nozzle bracket (part number 104592)
[supplied separately]

Figure 18 – Standard nozzle kits

Discharge Hose and Tube fittings

Type	Image	Part No.	Description
Hose Protector		40155	20mm Red - Suitable for 1/2" hose
		40154	25mm Red - Suitable for 3/4" hose
Couplings (Field Attachable)		87070	1/2" Hose x 3/4" JIC (f) swivel
		87071	3/4" Hose x 1 1/16" JIC (f) swivel
		87072	1/2" Hose x 3/4" JIC (m)
Cap/Nut		72039	3/4" JIC Nut & Sleeve to suit 1/2" Tube
Reducing Adaptor		72022	3/4" JIC (m) x 1 1/16" JIC (f)
Unions		72000	3/4" JIC
		72011	3/4" JIC Bulkhead
		72012	1 1/16" JIC Bulkhead
		72020	3/4" JIC x 3/4" BSP
Plug/Cap		72009	3/4" JIC (m)
		72002	3/4" JIC (f)
		72003	1 1/16" JIC cap
Tees		72005	3/4" JIC (m)
		72006	1 1/16" JIC (m)
		72007	3/4" JIC (m) x 3/4" JIC (m) x 1 1/16" JIC (m)
		72013	3/4" JIC (m) bulkhead
		72014	1 1/16" JIC (m) bulkhead
		72008	3/4" JIC (m) x 3/4" JIC (m) x 1/4" BSP (f)













Type	Image	Part No.	Description	
		72024	3/4" JIC (m) x 3/4" JIC (m) x 3/4" JIC (f)swv	
		72026	3/4" JIC (f)swv x 3/4" JIC (m) x 3/4" JIC (m)	
		72027	3/4" JIC (f)swv x 3/4" JIC (m) x 1 1/16" JIC (m)	
		72032	3/4" JIC (f)swv x 3/4" JIC (m) x 1/4" BSP (f)	
Elbows		72016	3/4" JIC (m & f) swivel	
		72017	1 1/16" JIC (m & f) swivel	
		72001	3/4" JIC (m)	
		72029	45° 3/4" JIC (m & f) swivel	
		72030	45° 1 1/16" JIC (m & f) swivel	
		72033	45° 1/4" BSP (f) x 3/4" JIC (m)	
Nozzle Bracket		104592	Size: 76x51x5 angle, 50mm width, Zinc plated	
Insulated P-Clip			Size	Spacing
		103198	1/2" Hose	0.7
		130080	1/2" Hose with Hose Protector	0.7
		103199	3/4" Hose	0.7
		130081	3/4" Hose with Hose Protector	0.7
Weld Lug		129578	M8 Weld Lug c/w bolt and washer for mounting P-Clips	
Welded Clamp Blocks			Size	Spacing
		132823	1/2" Tube	0.5
		112113	1/2" Hose	0.7
		128818	3/4" Hose	0.7
		94435	Bolt on Base to suit 132823	
			Size	Spacing
130073		Double 1/2" Tube	0.5	
	130074	Double 3/4" Hose	0.7	

Table 15 – PEFS F3N discharge hose & tube fittings

Actuation Components

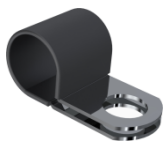
Loss of Pressure Detection Tubing

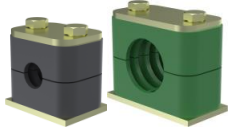
LOP tubing part number: 118837 (per metre)

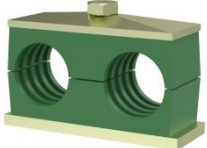
LOP detection tubing has an installed life of 1 year and must therefore be replaced annually as part of the regular maintenance routine.

Manual LOP Actuator



Figure 19 – LOP Manual Actuator

Part Number	Description
47130	LOP Manual Actuator
47131	LOP Manual Actuator – Flush Mount
28038	LOP Actuator Service Kit

Table 16 – LOP Manual Actuator Part Numbers

Electric Solenoid Valve Assembly

12V DC10W solenoid

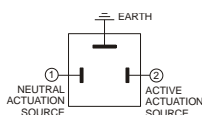
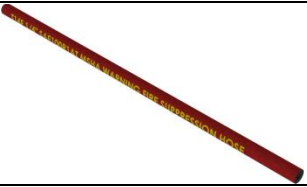





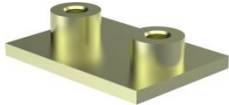











Figure 20- LOP solenoid valve assembly (part number ES9014-D)

Actuation System Fittings

Type	Image	Part No.	Description
¼" actuation hose		9344220356	¼" red coloured, 'FIRE SUPPRESSION' branded, oil resistant synthetic rubber with high tensile steel wire braid reinforcement meeting SAE 100R1AT specifications and U.S. MSHA 2G and AS2660 flame resistance requirements.
Hose Protector		40156	16mm Red - Suitable for ¼" hose
Hose Fittings (Field Attachable)		87073	1/4" Hose x 7/16" JIC (f)swv Field Attachable
LOP Tubing Coupling		128763	1/4" LOP tube x 7/16" JIC (m) Compression AN Union
LOP Tubing Cap		128764	1/4" LOP Tube EOL Compression Cap
Manifold Blocks		128760	6 x ¼" NPT(f), 2 x 1/8" NPT(f)
		128761	4 x ¼" NPT(f), 2 x 1/8" NPT(f)
Weld Clamp Plates		128841	20mm ctr to ctr (to suit 6 port Manifold Block)
		128842	33mm ctr to ctr (to suit 8 port Manifold Block)
Bolts		91319	M6 x 35mm Hex Head (for Manifold Block)
		91320	M6 x 40mm Hex Head (for Manifold Block)
Tee		72004	7/16" JIC (m)
		72025	7/16" JIC (f) x 7/16" JIC (m) x 7/16" JIC (m)
		72023	7/16" JIC (m) x 7/16" JIC (m) x 7/16" JIC (f)
		112149	1/4" NPT (f)
Elbow		72015	7/16" JIC (m & f) swv
		72028	45° 7/16" JIC (m & f) swv
		72043	7/16" JIC (m) x 1/8" NPT (m)
Plug		118551	1/8" NPT
		119568	1/4" NPT
Nipple		72010	7/16" JIC Bulkhead

Type	Image	Part No.	Description	
		72018	1/8" NPT x 7/16" JIC	
		72019	1/4" NPT x 7/16" JIC	
		115443	1/8" NPT (m)	
Socket		130131	1/8" NPT (f)	
Adaptor		72045	1/4" NPT (m) x 7/16" JIC (f)swv	
Insulated P-Clip			Size	Maximum Spacing (m)
		128819	1/4" Tube	0.5
		103197	1/4" Hose	0.5
		103198	Use with Grommet 103248	0.5
	130078	1/4" Hose with hose protector	0.5	
Grommet		103248	Grommet to hold LOP tubing. Use with P-Clip 103198.	
Weld Lug		129578	M8 Weld Lug c/w bolt and washer for mounting P-Clips	

Table 17 – PEFS F3N pneumatic actuation hose and tube fittings

Monitoring Components

Pressure Switches

- “Cylinder low pressure”, 1450kPa NO Blue (part number 87067)
- “Fire Alarm/Discharge”, 200kPa NC Black (part number 87069)

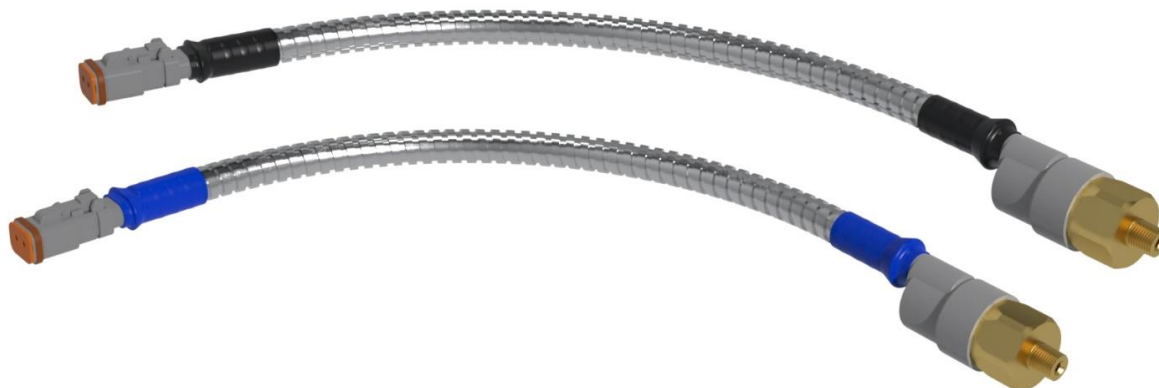

Figure 21 – Pressure Switches

Identification & Instruction Labels



part number 66534



part number 66535



part number 66536



part number 66537



part number 66137

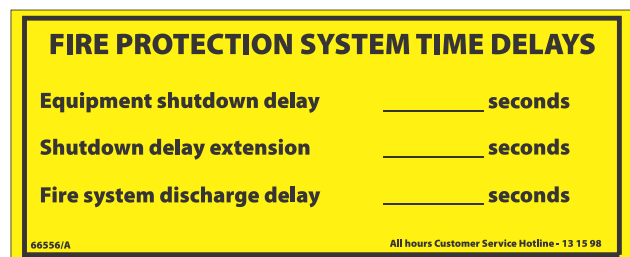

part number 66556



part number 66557

Table 18 - Identification & instruction labels

APPENDIX

SDS – Chubb PEFS F3N Foam Concentrate

Chubb

SAFETY DATA SHEET

1. IDENTIFICATION OF THE MATERIAL AND SUPPLIER**1.1 Product identifier**

Product name CHUBB PEFS F3N FOAM CONCENTRATE

Synonyms FOAM CONCENTRATE

1.2 Uses and uses advised against

Uses FIRE EXTINGUISHING AGENT • FIRE FIGHTING FOAM • FIRE SUPPRESSANT

1.3 Details of the supplier of the product

Supplier name CHUBB FIRE & SECURITY AUSTRALASIA

Address 314 Boundary Rd, Dingley, VIC, 3172, AUSTRALIA

Telephone 1300 369 309

Website www.chubb.com.au

1.4 Emergency telephone numbers

Emergency 1300 369 309

2. HAZARDS IDENTIFICATION**2.1 Classification of the substance or mixture**

CLASSIFIED AS HAZARDOUS ACCORDING TO SAFE WORK AUSTRALIA CRITERIA

Physical Hazards

Not classified as a Physical Hazard

Health Hazards

Serious Eye Damage / Eye Irritation: Category 1

Environmental Hazards

Not classified as an Environmental Hazard

2.2 GHS Label elements

Signal word DANGER

Pictograms**Hazard statements**

H318 Causes serious eye damage.

Prevention statements

None allocated.

Response statements

P305 + P351 + P338 IF IN EYES: Rinse cautiously with water for several minutes. Remove contact lenses, if present and easy to do. Continue rinsing.

P310 Immediately call a POISON CENTER or doctor/physician.

Storage statements

None allocated.

ChemAlert.

Page 1 of 7

SDS Date: 10 Jun 2020
Revision No: 1

PRODUCT NAME CHUBB PEFS F3N FOAM CONCENTRATE**Disposal statements**

None allocated.

2.3 Other hazards

May produce an allergic reaction.

3. COMPOSITION/ INFORMATION ON INGREDIENTS**3.1 Substances / Mixtures**

Ingredient	CAS Number	EC Number	Content
NON HAZARDOUS INGREDIENTS	Not Available	Not Available	Remainder
SACCHARIDES	-	-	<40%
DIETHYLENE GLYCOL BUTYL ETHER	112-34-5	203-961-6	<15%
TRIETHANOLAMINE LAURYL SULPHATE	139-96-8	205-388-7	<5%
1-PROPANAMINIUM, N-(3-AMINOPROPYL)-2-HYDROXY-N,N-DIMETHYL-3-SULFO-, N-(C12-18(EVEN NUMBERED) ACYL) DERIVS., HYDROXIDES, INNER SA	1469983-50-3	939-457-4	<3%
POLYGLYCOL(S)	-	-	<3%
SURFACTANT(S)	-	-	<3%
N-(2-HYDROXYETHYL)-N-[2-[(1-OXOOCTYL)AMINO]ETHYL]-B-ALANINE	64265-45-8	264-761-2	<1%
WATER	7732-18-5	231-791-2	<40%
(CARBOXYMETHYL)DIMETHYL-3-[(1-OXODODECYL)AMINO]PROPYLAMMONIUM HYDROXIDE	4292-10-8	224-292-6	<3%
CORROSION INHIBITOR(S)	-	-	<0.3%

Ingredient Notes Chubb PEFS F3N Foam Concentrate does not contain any persistent organic chemicals such as fluorinated organic substances (PFAS).

4. FIRST AID MEASURES**4.1 Description of first aid measures**

Eye	If in eyes, hold eyelids apart and flush continuously with running water. Continue flushing until advised to stop by a Poisons Information Centre, a doctor, or for at least 15 minutes.
Inhalation	If inhaled, remove from contaminated area. To protect rescuer, use an Air-line respirator where an inhalation risk exists. Apply artificial respiration if not breathing.
Skin	If skin or hair contact occurs, remove contaminated clothing and flush skin and hair with running water. Continue flushing with water until advised to stop by a Poisons Information Centre or a doctor.
Ingestion	For advice, contact a Poisons Information Centre on 13 11 26 (Australia Wide) or a doctor (at once). If swallowed, do not induce vomiting.
First aid facilities	Eye wash facilities should be available.

4.2 Most important symptoms and effects, both acute and delayed

See Section 11 for more detailed information on health effects and symptoms.

4.3 Immediate medical attention and special treatment needed

Treat symptomatically.

5. FIRE FIGHTING MEASURES**5.1 Extinguishing media**

Extinguishing agent.

5.2 Special hazards arising from the substance or mixture

Non flammable. May evolve carbon oxides and hydrocarbons when heated to decomposition.

PRODUCT NAME CHUBB PEFS F3N FOAM CONCENTRATE**5.3 Advice for firefighters**

Treat as per requirements for surrounding fires. Evacuate area and contact emergency services. Remain upwind and notify those downwind of hazard. Wear full protective equipment including Self Contained Breathing Apparatus (SCBA) when combating fire. Use waterfog to cool intact containers and nearby storage areas.

5.4 Hazchem code

None allocated.

6. ACCIDENTAL RELEASE MEASURES**6.1 Personal precautions, protective equipment and emergency procedures**

Wear Personal Protective Equipment (PPE) as detailed in section 8 of the SDS.

6.2 Environmental precautions

Prevent product from entering drains and waterways.

6.3 Methods of cleaning up

Contain spillage, then cover / absorb spill with non-combustible absorbent material (vermiculite, sand, or similar), collect and place in suitable containers for disposal.

6.4 Reference to other sections

See Sections 8 and 13 for exposure controls and disposal.

7. HANDLING AND STORAGE**7.1 Precautions for safe handling**

Before use carefully read the product label. Use of safe work practices are recommended to avoid eye or skin contact and inhalation. Observe good personal hygiene, including washing hands before eating. Prohibit eating, drinking and smoking in contaminated areas.

7.2 Conditions for safe storage, including any incompatibilities

Store in an area designated for fire extinguishers. Signs should indicate fire extinguisher location. Extinguishers should be kept cool and dry and should not come into contact with any chemicals. Check regularly to ensure extinguishers are in good working order. Store between -15°C and 50°C.

7.3 Specific end uses

No information provided.

8. EXPOSURE CONTROLS / PERSONAL PROTECTION**8.1 Control parameters****Exposure standards**

Ingredient	Reference	TWA		STEL	
		ppm	mg/m ³	ppm	mg/m ³
Diethylene glycol butyl ether	SWA [Proposed]	10	67.5	--	--

Biological limits

No biological limit values have been entered for this product.

8.2 Exposure controls

Engineering controls Avoid inhalation. Use in well ventilated areas. In a fire situation, ventilation may be difficult to control. Contact emergency personnel.

PRODUCT NAME CHUBB PEFS F3N FOAM CONCENTRATE

PPE

Eye / Face	Wear splash-proof goggles.
Hands	Wear PVC or rubber gloves.
Body	When using large quantities or where heavy contamination is likely, wear coveralls.
Respiratory	Where an inhalation risk exists, wear a Type A-Class P1 (Organic gases/vapours and Particulate) respirator.



9. PHYSICAL AND CHEMICAL PROPERTIES

9.1 Information on basic physical and chemical properties

Appearance	AMBER LIQUID
Odour	CHARACTERISTIC ODOUR
Flammability	NON FLAMMABLE
Flash point	NOT RELEVANT
Boiling point	90°C to 110°C
Melting point	NOT AVAILABLE
Evaporation rate	NOT AVAILABLE
pH	7.0 to 9.0
Vapour density	NOT AVAILABLE
Specific gravity	NOT AVAILABLE
Solubility (water)	SOLUBLE
Vapour pressure	NOT AVAILABLE
Upper explosion limit	NOT RELEVANT
Lower explosion limit	NOT RELEVANT
Partition coefficient	NOT AVAILABLE
Autoignition temperature	NOT AVAILABLE
Decomposition temperature	NOT AVAILABLE
Viscosity	< 50 mPa·s @ 20°C
Explosive properties	NOT EXPLOSIVE
Oxidising properties	NOT AVAILABLE
Odour threshold	NOT AVAILABLE

9.2 Other information

Freezing point	< -15°C
Density	1.125 g/cm ³ to 1.145 g/cm ³ @ 20°C

10. STABILITY AND REACTIVITY

10.1 Reactivity

Carefully review all information provided in sections 10.2 to 10.6.

10.2 Chemical stability

Stable under recommended conditions of storage.

10.3 Possibility of hazardous reactions

Polymerization will not occur.

10.4 Conditions to avoid

No known conditions to avoid.

10.5 Incompatible materials

Incompatible with oxidising agents (e.g. hypochlorites) and acids (e.g. nitric acid).

10.6 Hazardous decomposition products

May evolve carbon oxides and hydrocarbons when heated to decomposition.

PRODUCT NAME **CHUBB PEFS F3N FOAM CONCENTRATE**

11. TOXICOLOGICAL INFORMATION

11.1 Information on toxicological effects

Acute toxicity	Acute oral exposure may result in irritation of the mouth, throat, oesophagus and gastrointestinal tract. Under extreme temperatures in a fire situation toxic by-products associated with this extinguishing agent and surrounding materials may be generated.
Skin	Contact may result in irritation, rash and dermatitis.
Eye	Contact may result in irritation, lacrimation, pain, redness and possible serious eye damage.
Sensitisation	Not classified as causing skin or respiratory sensitisation. Contains N-(2-hydroxyethyl)-N-[[2-[(1-oxooctyl) amino] ethyl]-beta-alanine, which may produce an allergic reaction.
Mutagenicity	Not classified as a mutagen.
Carcinogenicity	Not classified as a carcinogen.
Reproductive	Not classified as a reproductive toxin.
STOT - single exposure	Over exposure may result in irritation of the nose and throat, with coughing. Under extreme temperatures in a fire situation toxic by-products associated with this extinguishing agent and surrounding materials may be generated.
STOT - repeated exposure	Not classified as causing organ damage from repeated exposure. However, repeated exposure to some glycols may result in kidney damage.
Aspiration	Not classified as causing aspiration.

12. ECOLOGICAL INFORMATION

12.1 Toxicity

No information provided.

12.2 Persistence and degradability

No information provided.

12.3 Bioaccumulative potential

No information provided.

12.4 Mobility in soil

Avoid the contamination of the soil and water: If surfactants mixture penetrate soil, it will be mobile and may contaminate groundwater and surface water.

12.5 Other adverse effects

No information provided.

13. DISPOSAL CONSIDERATIONS

13.1 Waste treatment methods

Waste disposal	For small amounts, absorb with sand, vermiculite or similar and dispose of to an approved landfill site. For large quantities, contact the manufacturer/supplier for additional information. Prevent contamination of drains and waterways as aquatic life may be threatened and environmental damage may result.
Legislation	Dispose of in accordance with relevant local legislation.

14. TRANSPORT INFORMATION

NOT CLASSIFIED AS A DANGEROUS GOOD BY THE CRITERIA OF THE ADG CODE, IMDG OR IATA

	LAND TRANSPORT (ADG)	SEA TRANSPORT (IMDG / IMO)	AIR TRANSPORT (IATA / ICAO)
14.1 UN Number	None allocated.	None allocated.	None allocated.
14.2 Proper Shipping Name	None allocated.	None allocated.	None allocated.
14.3 Transport hazard class	None allocated.	None allocated.	None allocated.
14.4 Packing Group	None allocated.	None allocated.	None allocated.

PRODUCT NAME **CHUBB PEFS F3N FOAM CONCENTRATE**

14.5 Environmental hazards

Not a Marine Pollutant

14.6 Special precautions for user

Hazchem code None allocated.

15. REGULATORY INFORMATION

15.1 Safety, health and environmental regulations/legislation specific for the substance or mixture

Poison schedule A poison schedule number has not been allocated to this product using the criteria in the Standard for the Uniform Scheduling of Medicines and Poisons (SUSMP).

Classifications Safework Australia criteria is based on the Globally Harmonised System (GHS) of Classification and Labelling of Chemicals.

Inventory listings **AUSTRALIA: AICS (Australian Inventory of Chemical Substances)**
All components are listed on AICS, or are exempt.

16. OTHER INFORMATION

Additional information **PERSONAL PROTECTIVE EQUIPMENT GUIDELINES:**
The recommendation for protective equipment contained within this report is provided as a guide only. Factors such as form of product, method of application, working environment, quantity used, product concentration and the availability of engineering controls should be considered before final selection of personal protective equipment is made.

HEALTH EFFECTS FROM EXPOSURE:
It should be noted that the effects from exposure to this product will depend on several factors including: form of product; frequency and duration of use; quantity used; effectiveness of control measures; protective equipment used and method of application. Given that it is impractical to prepare a report which would encompass all possible scenarios, it is anticipated that users will assess the risks and apply control methods where appropriate.

Abbreviations	ACGIH	American Conference of Governmental Industrial Hygienists
	CAS #	Chemical Abstract Service number - used to uniquely identify chemical compounds
	CNS	Central Nervous System
	EC No.	EC No - European Community Number
	EMS	Emergency Schedules (Emergency Procedures for Ships Carrying Dangerous Goods)
	GHS	Globally Harmonized System
	GTEPG	Group Text Emergency Procedure Guide
	IARC	International Agency for Research on Cancer
	LC50	Lethal Concentration, 50% / Median Lethal Concentration
	LD50	Lethal Dose, 50% / Median Lethal Dose
	mg/m ³	Milligrams per Cubic Metre
	OEL	Occupational Exposure Limit
	pH	relates to hydrogen ion concentration using a scale of 0 (high acidic) to 14 (highly alkaline).
	ppm	Parts Per Million
	STEL	Short-Term Exposure Limit
	STOT-RE	Specific target organ toxicity (repeated exposure)
	STOT-SE	Specific target organ toxicity (single exposure)
	SUSMP	Standard for the Uniform Scheduling of Medicines and Poisons
	SWA	Safe Work Australia
	TLV	Threshold Limit Value
	TWA	Time Weighted Average

PRODUCT NAME CHUBB PEFS F3N FOAM CONCENTRATE

Report status This document has been compiled by RMT on behalf of the manufacturer, importer or supplier of the product and serves as their Safety Data Sheet ('SDS').

It is based on information concerning the product which has been provided to RMT by the manufacturer, importer or supplier or obtained from third party sources and is believed to represent the current state of knowledge as to the appropriate safety and handling precautions for the product at the time of issue. Further clarification regarding any aspect of the product should be obtained directly from the manufacturer, importer or supplier.

While RMT has taken all due care to include accurate and up-to-date information in this SDS, it does not provide any warranty as to accuracy or completeness. As far as lawfully possible, RMT accepts no liability for any loss, injury or damage (including consequential loss) which may be suffered or incurred by any person as a consequence of their reliance on the information contained in this SDS.

Prepared by Risk Management Technologies
5 Ventnor Ave, West Perth
Western Australia 6005
Phone: +61 8 9322 1711
Fax: +61 8 9322 1794
Email: info@rmt.com.au
Web: www.rmtglobal.com

[End of SDS]

AS2337 Cylinder Visual Inspection Damage Limits

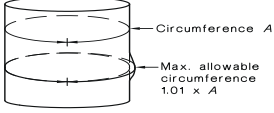
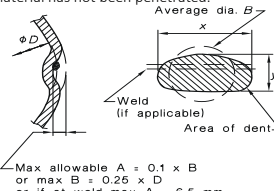
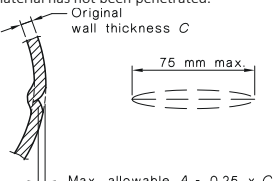
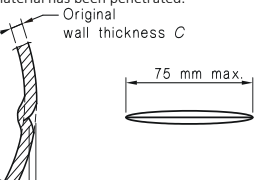
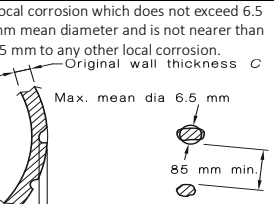
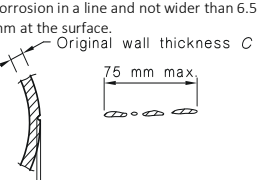
Name	Definitions and illustrations (with limits)	Limits and treatment					
		General	C23	C30	C45	C65	C106
Bulge	A swelling of the cylinder or vessel wall. 	Condemn where measured circumference varies by more than 1% between any two similar sections of the cylinder.	Variance 6.9mm	Variance 10.1mm	Variance 11.4mm	Variance 11.4mm	Variance 11.4mm
Dent	A blunt impression where the surface material has not been penetrated. 	Condemn where— (a) the depth of dent exceeds 10% of the average dent diameter (b) the average diameter of dent exceeds 25% of the cylinder diameter; or (c) the dent impinges on a weld and it exceeds 6.5 mm in depth Average dent diameter B is taken to be $(y + x)/2$	Dent OD 55mm	Dent OD 80.5mm	Dent OD 91mm	Dent OD 91mm	Dent OD 91mm
Dig	A sharp impression where the surface material has not been penetrated. 	Condemn where length of dig exceeds 75 mm, or the depth of the dig exceeds 25% of the original wall thickness.	Depth 0.5mm	Depth 0.5mm	Depth 0.5mm	Depth 0.5mm	Depth 0.5mm
Cut (gouge)	A sharp impression where the surface material has been penetrated. 	Condemn where the length of cut exceeds 75 mm, or the depth of the cut exceeds 25% of the original wall thickness.	Depth 0.5mm	Depth 0.5mm	Depth 0.5mm	Depth 0.5mm	Depth 0.5mm
Pit	Local corrosion which does not exceed 6.5 mm mean diameter and is not nearer than 85 mm to any other local corrosion. 	Condemn where depth of the pit is greater than 50% of original wall thickness. Where the distance between adjacent pits is less than 85 mm, treat as general corrosion.	Depth 1mm	Depth 1mm	Depth 1mm	Depth 1mm	Depth 1mm
Line corrosion or linear wear or abrasion	Corrosion in a line and not wider than 6.5 mm at the surface.  NOTE: Line corrosion occurs most commonly at a junction with an attachment such as a foot-ring.	Condemn where the length exceeds 75 mm, or the depth exceeds 25% of the original wall thickness.	Depth 0.5mm	Depth 0.5mm	Depth 0.5mm	Depth 0.5mm	Depth 0.5mm
General corrosion	Any corrosion more extensive than pit or line corrosion.	Condemn where mass check in accordance with AS2337.1 Section 8 is failed, or where depth of corrosion exceeds 25% of the original wall thickness.	Depth 0.5mm	Depth 0.5mm	Depth 0.5mm	Depth 0.5mm	Depth 0.5mm
Cracks	A crack or rift in the metal.	Condemn (see AS2337.1 Appendix H)					
Gas leakage	Any gas leakage through the cylinder, or at the valve due to damaged or worn cylinder neck threads. NOTE: Areas around the base of the cylinder are particularly susceptible to gas leakage.	Condemn where any leak is detected. Where leakage is suspected, the cylinder shall be pressured to working pressure and either submerged in a water bath or bathed with soapy water, and observed to determine whether or not leakage occurs. Cylinders which have leakage due to damage to threaded openings may be repaired, provided that this is permitted by AS2030.1 and the cylinder specifications. Otherwise, such cylinders shall be condemned.					
Burns	A localized heat-affected region of the cylinder wall. NOTE: Burns may result from contact with an electric arc or an oxygen-acetylene flame.	Where surface damage is evident, either the cylinder shall be condemned or the affected surface ground smooth and any remaining cuts and pits treated in accordance with 'cut (gouge)' and 'pit'. Where the limits are not exceeded, the cylinder shall then be re-heat treated in accordance with AS2337.1 Clause 9.4, and then hydraulically pressure tested in accordance with AS2337.1 Section 7. For cylinders with heat affected regions but no evidence of surface damage, treat as fire damaged as specified in 'Fire damage' below.					

Name	Definitions and illustrations (with limits)	Limits and treatment				
		General	C23	C30	C45	C65
Fire and heat damage	Any damage resulting from a fire or excessive or unusual application of heat.	Condemn where — (a) warping or distortion is evident; (b) bulging exceeds limits specified for a bulge; or (c) there is evidence of damage from excessive heat. Where a steel cylinder has not suffered damage to the extent specified in (a), (b), or (c) above, but has burned areas exceeding 6000 mm ² , it shall either be re-heat treated and tested where appropriate, in accordance with the original manufacturing specification, and hydraulically pressure tested in accordance with AS2337.1 Section 7, or shall be condemned. Where the burned areas of a steel cylinder do not exceed 6000 mm ² , the cylinders may be returned to service.				
Cylinder Neck	Cylinder neck inspection includes both external and internal inspections of the neck area. The cylinder to valve thread of the cylinder shall be examined to ensure that it is— (a) clean and of full form; (b) free of significant damage; (c) free of burrs; (d) free of cracks; and (e) free of other significant imperfections that would affect the integrity of the connection.	Condemn where the neck thread shows evidence of cracks, damage or excessive wear except where gauging with a thread gauge complying with AS2473 shows the thread to be satisfactory.				